

www.flyeaglejet.com							Home	About us	Contacts	Guestbook
Index	F16 Advanced [1:8]	F16 [1:8]	F16 [1:5 1/2]	F15c [1:9 1/2]	F15c Advanced [1:9 1/2]	F15E [1:7]				
AT3[1:5 1/2]	Rafale [1:9]	Rafale EDF [1:9]	F18F [1:7]	F-18F [1:8.75]	L39 [1:7]	L39 [1:5 1/2]				
Trainer	F35A [1:6 1/2]	F14 [1:7 1/2]	Tornado [1:7 1/2]	BAe Hawk [1:5 1/2]	Liberty	F100 test				
Mig 29 test	P40 test	Helicopter	Accessories	Turbine	Instruction Manuals	About us				
Freight Cost	Gallery	Contacts	Contact USA Office	Electronic items	Payment Terms					

Flyeaglejet ARF **F-16 (1:5 1/2)** Instruction Manuals

F16 1:5 1/2 THROWS AND CG

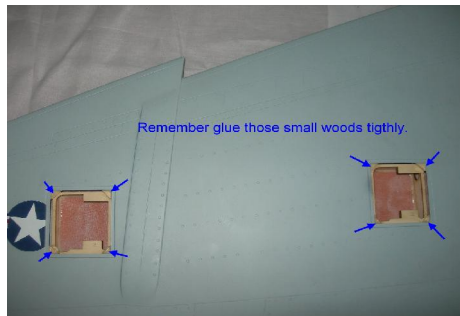
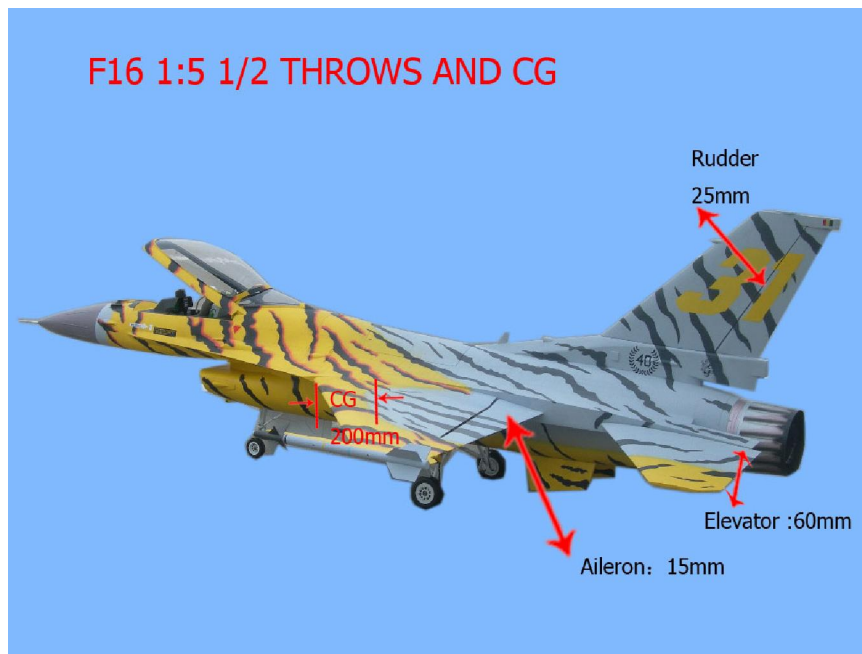

Remember

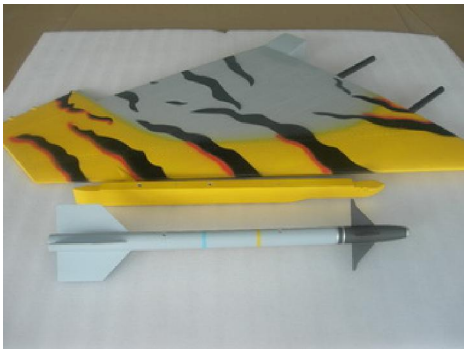
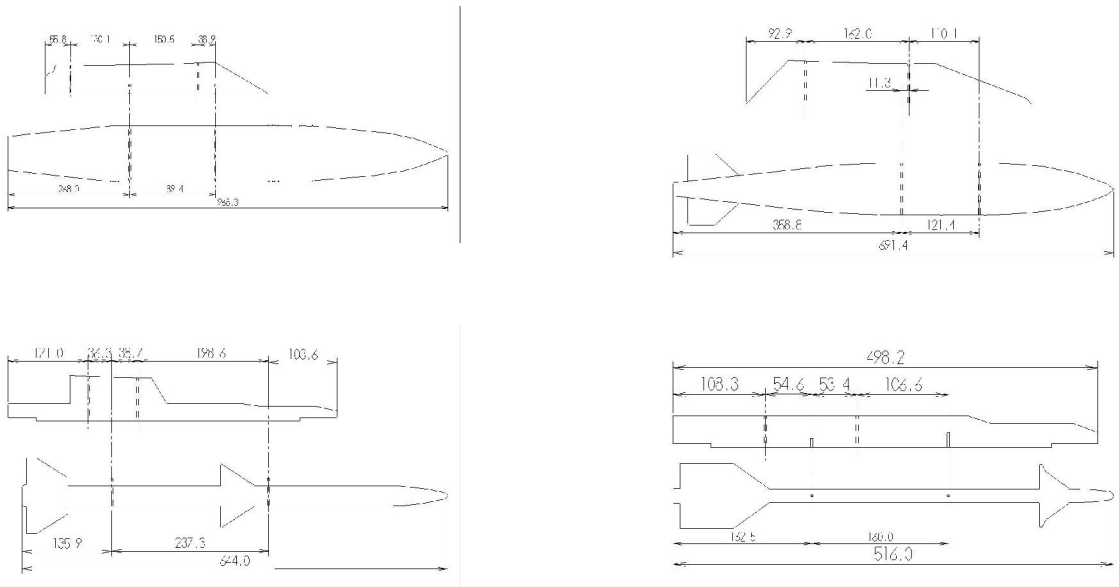

(01)



(02)



(03)



(04)



(05)

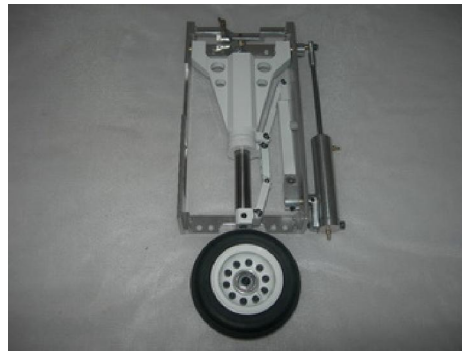

(06)

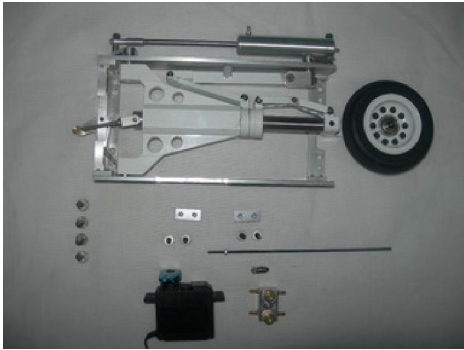

(07)

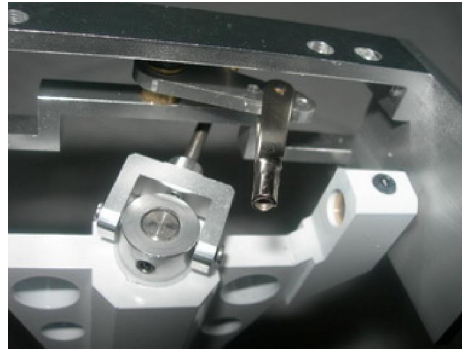

(08)



(09)



(10)

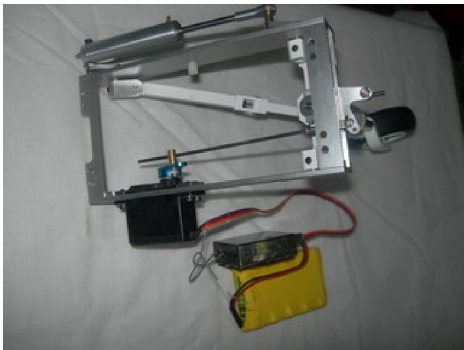

(11)



(12)



(13)



(14)

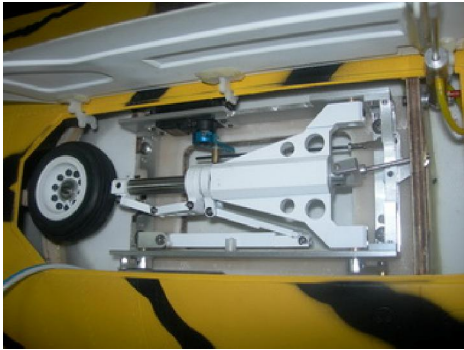

(15)



(16)



(17)



(18)



(19)



(20)



(21)



(22)



(23)



(24)



(25)



(26)



(27)



(28)



(29)

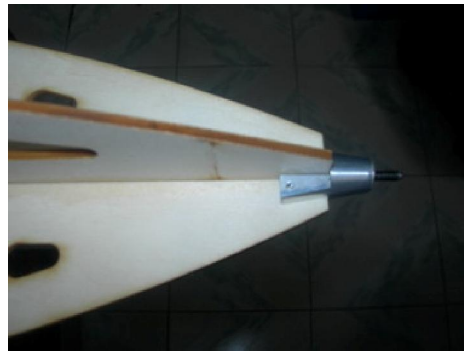

(30)

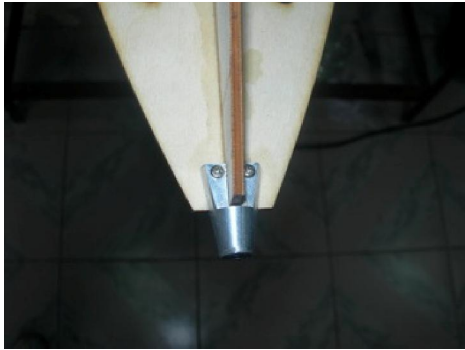

(31)



(32)



(33)

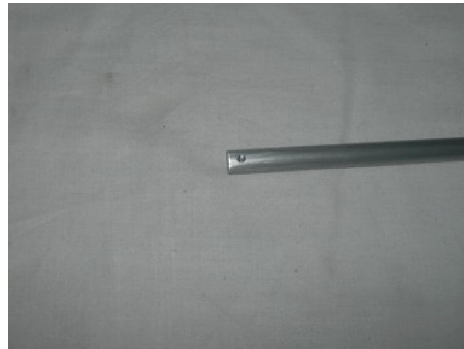

(34)



(35)



(36)

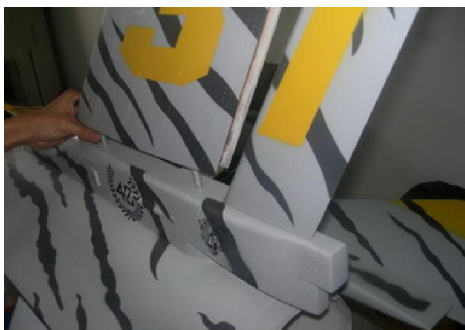

(37)



(38)



(39)



(40)



(41)



(42)



(43)



(44)



(45)



(46)

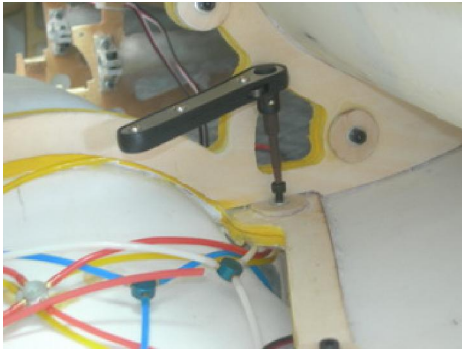

(47)

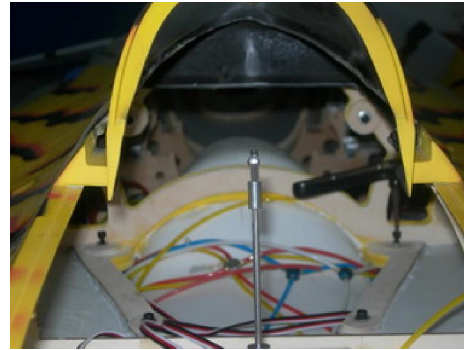

(48)

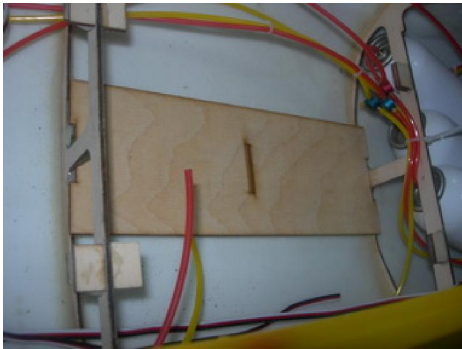

(49)

HOME | ACCESSORIES | Contacts | ABOUT US
Copyright © 2005-2007, www.flyeaglejet.com. All rights reserved.
E-mail: hc@flyeaglejet.com