





### Accessory list for this page.

-  TP Screw (2.6x14mm) ----- 8
-  Washer (3x6mm) ----- 8
-  Wood dowel (12x50mm) ----- 8

### 3

Fix the alu plank to the gun.

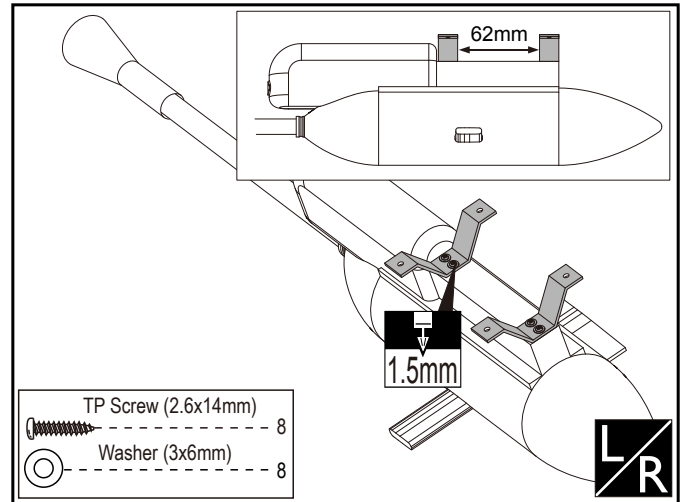

### 1

Epoxy the two parts of gun tube together steadily.

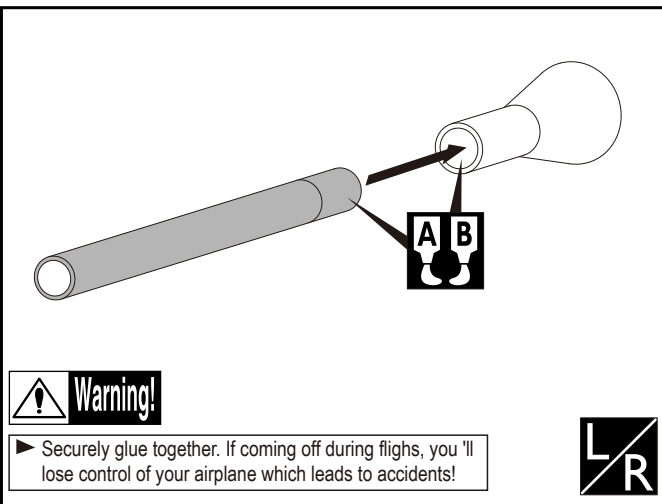

### 4

Drill four holes at the bottom of the wing.

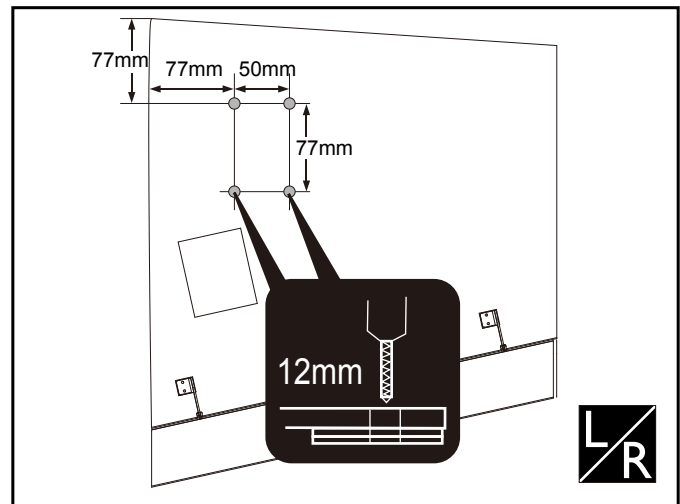

### 2

Epoxy the gun tube to the gun body.

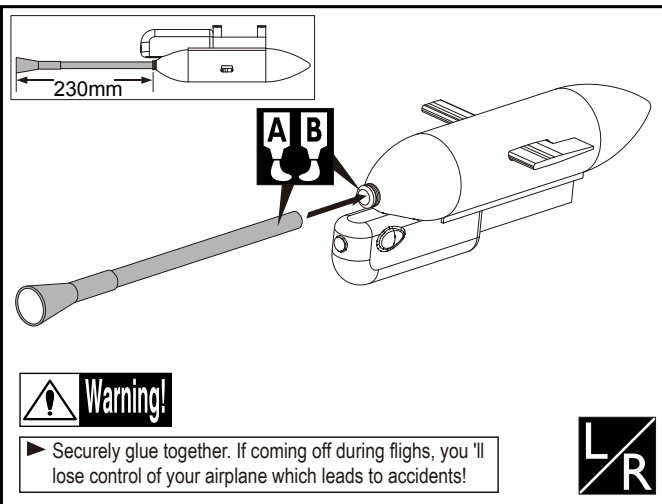

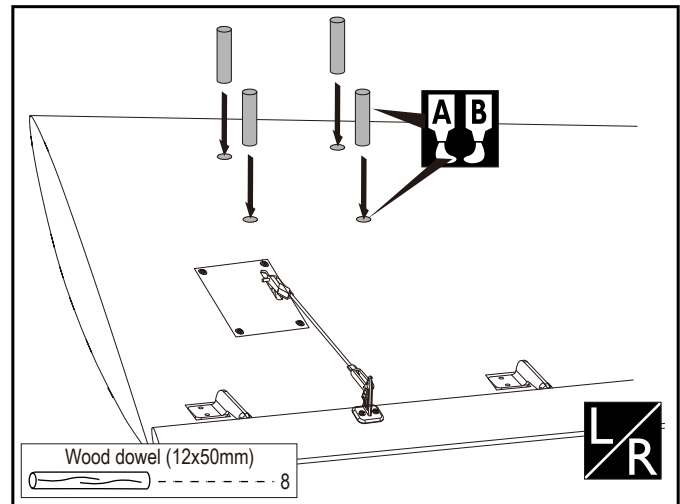

### 5

Epoxy wooden dowels to the four holes tightly.





 Apply epoxy glue.

 Assemble left and right sides the same way.

 Pay close attention here!

Do not overlook this symbol!

 Apply instant glue (CA glue, super glue).

 Ensure smooth non-binding movement while assembling.

 Cut off shaded portion.





Accessory list for this page.

- TP Screw (2.6x14mm) ----- 8
- Washer (3x6mm) ----- 8

**6** Cut away the surplus parts of the woode dowels.

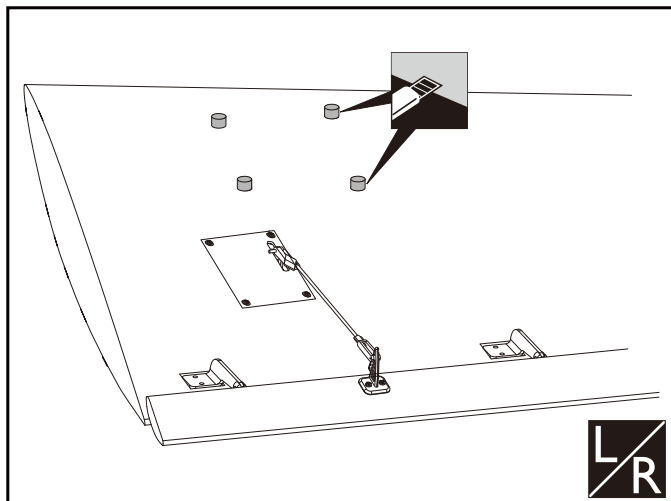

**7** Mount the gun to the wing.

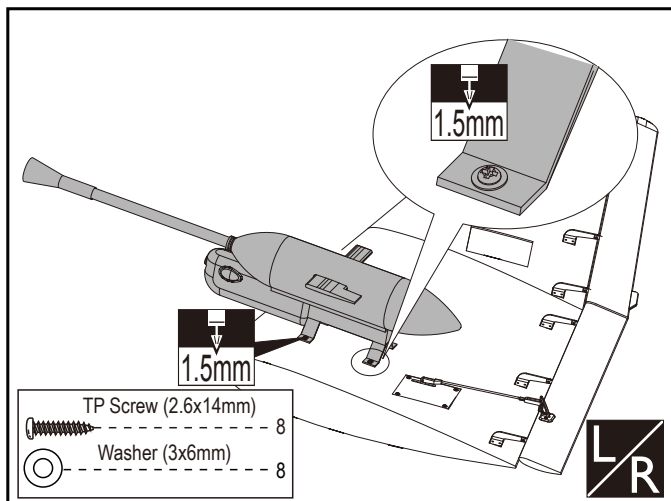

Apply epoxy glue.

Assemble left and right sides the same way.

Pay close attention here!

Do not overlook this symbol!

Apply instant glue (CA glue, super glue).

Ensure smooth non-binding movement while assembling.

Cut off shaded portion.

